



EZ Way, Inc.

*"Your Total Safe Patient Handling Partner"*

## **EZ Ceiling Lift System**

### **CL650, CL1000**

### **Owner's Manual**

- ◆ Use and features
- ◆ Warranty
- ◆ Specifications



EZ Way, Inc.  
PO Box 89  
Clarinda, IA 51632  
1-800-627-8940  
[www.ezlifts.com](http://www.ezlifts.com)

Form #2-209  
Rev. 10/24/2024

**⚠WARNING:** Cancer and Reproductive Harm - [www.P65Warnings.ca.gov](http://www.P65Warnings.ca.gov).

The EZ Way Ceiling Lift was designed primarily to lift and transfer patients along a track mounted to the ceiling. The maximum lifting capacity is located by the model and serial number of your lift. The EZ Way Ceiling Lift was designed to be operated safely by one person. However, with some patients it is best to use two people.

---

## Safety Notes

The EZ Way Ceiling Lift was designed primarily to lift and transfer patients along a track mounted to the ceiling.

For safe operation of the EZ Way Ceiling Lift, operators should read through this manual, complete the competency checklist, and practice on fellow staff members before use with patients.

The EZ Way Ceiling Lift comes in 650 and 1,000 lb. weight capacities. All washable EZ Way slings are capable of bearing a 1,000 lb. weight load, but must only be used to hold the amount of weight dictated by the EZ Way Ceiling Lift capacity. The maximum lifting capacity of each EZ Way Ceiling Lift is located on the back of the motor housing (See FIG.1) on page 5 and on the face of the motor. (See FIG. 2) on page 5.

Do not modify the sling design in any way. Please make sure the accessories used with each lift are appropriate for both the patient and the transferring situation and call EZ Way at 1-800-627-8940 if you have any questions.

EZ Way slings are made specifically for EZ Way Lifts. For the safety of the patient and caregiver, only EZ Way slings should be used with EZ Way Lifts.

The EZ Way Ceiling Lift was designed to be operated safely by one caregiver. However, depending on the situation, facility policy, and the patient's condition, two caregivers may be necessary.

*The hand control and emergency pull cord is not a tether.* Using the electrical hand control as a tether will damage the electrical cord.

All EZ Way equipment must be maintained regularly by competent staff according to the maintenance checklist provided.

These instructions should be kept with the EZ Way Ceiling Lift at all times. Instructions can also be downloaded from EZ Way's website [www.ezlifts.com](http://www.ezlifts.com).

## LIMITED WARRANTY: Ceiling Lifts

Chassis = 10 Years

Components = 3 Years

Batteries = 12 Months

Slings = 6 Months

Lift Strap = 12 Months

EZ Products are manufactured with the highest quality components. EZ Way Inc. warrants that all new equipment, with normal use and service, will be free from defects in material and workmanship for a period of (see above) from the date of purchase by the original purchaser. Normal wear and tear, injury by natural forces, user neglect and purposeful destruction are not covered by this warranty. Warranty service must be performed by the manufacturer at 710 E. Main St., Clarinda, Iowa., or by an authorized repair center at their location. On occasion, EZ Way Inc. may authorize in-house repairs, but these repairs MUST be pre-approved to avoid invalidation of the warranty. Services covered under warranty include any labor that takes place at EZ Way Inc. Cost of Labor incurred while installing the warranty part at the place of ownership is not covered by this warranty. EZ Way Inc.'s obligation is limited to the replacement of parts that have been returned and are determined by EZ Way Inc. to be defective. THE PROVISIONS OF THIS WARRANTY CLAUSE ARE IN LIEU OF ALL OTHER WARRANTIES, EXPRESSED OR IMPLIED, AND OF ALL OTHER OBLIGATIONS OR LIABILITIES ON EZ WAY INC.'S PART AND IT NEITHER ASSUMES OR AUTHORIZES ANY OTHER PERSON TO ASSUME FOR EZ WAY INC. ANY OTHER LIABILITIES IN CONNECTION WITH THE SALE OF SAID ARTICLE. IN NO EVENT SHALL EZ WAY INC. BE LIABLE FOR ANY SUBSEQUENTIAL OR SPECIAL DAMAGES. ANY MISUSE, IMPROPER INSTALLATION OR TAMPERING SHALL VOID THIS WARRANTY. Your warranty was registered automatically by EZ Way Inc. at time of purchase.

## LCD Display

The EZ Way Ceiling Lift includes a built-in operator interface, backlit LCD (liquid crystal display) and key switches located on the front panel. This interface notifies the user of basic functions as well as provides diagnostic feedback from the unit.

### *Basic Functions*

The UP and DOWN keys located on the front panel and arrow keys on the hand control can all be used to operate the EZ Way Ceiling Lift in an up or down direction.

When an UP switch is pressed the display reads 'UP'.

When a DOWN switch is pressed the display reads 'DOWN'.

### *Battery Status*

When the EZ Way Ceiling Lift is sitting idle, the display shows the battery level. The battery level is shown as a bar graph. The fewer the bars displayed the lower the battery level.

When the battery level becomes low, charge the battery. Regular battery charging will extend the life of your batteries.



## To Operate the EZ Way Ceiling Lift, Follow the Steps Below:

### Pre-Operation Check

Before operating the EZ Ceiling Lift, a brief safety check should be completed:

- Check the battery level to ensure that there is enough charge to complete a transfer.
- Check lift strap. If strap shows signs of excessive wear, do not use lift.
- Ensure that the sling is not ripped, frayed or showing signs of wear.

If the unit fails to operate, contact your maintenance person. If necessary, the maintenance person can call our service department at 1-800-627-8940. **NOTE: It is helpful for the maintenance person to be near the unit when making the service call.**

### Turn Unit On

Push the power button on the remote control. (See FIG. 3) The EZ Way Ceiling Lift will display a greeting message while several diagnostic functions are performed. The EZ Way Ceiling Lift has a built-in timer that automatically shuts off the unit after a period of inactivity.

The EZ Way Ceiling Lift is operational when the battery charge level is showing on the screen. (See FIG. 2)

### Emergency Stop Switch

The RED EMERGENCY STOP BUTTON must be in the “in” position. The unit will not operate if the cord has been pulled. If the emergency stop cord has been pulled, the screen will indicate “EMERGENCY STOP”. Push the switch in to return to normal operation.

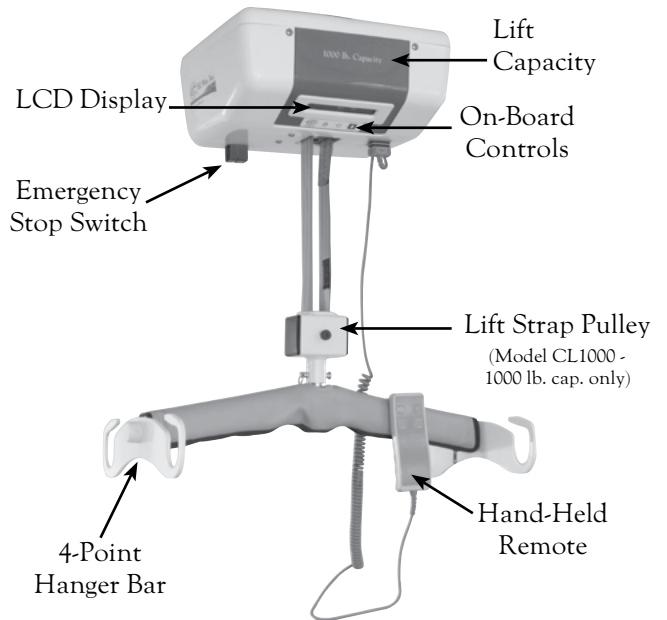

Figure 1

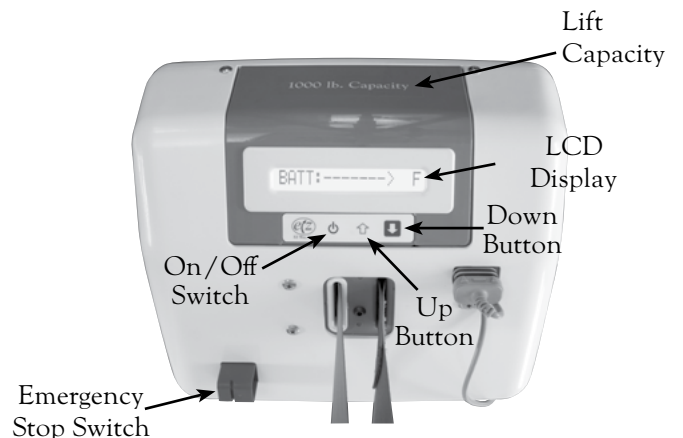

Figure 2

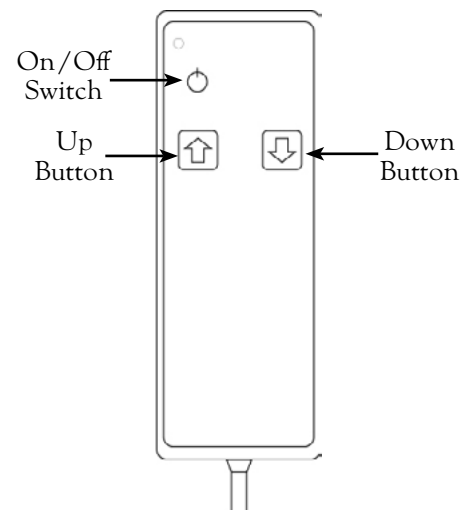
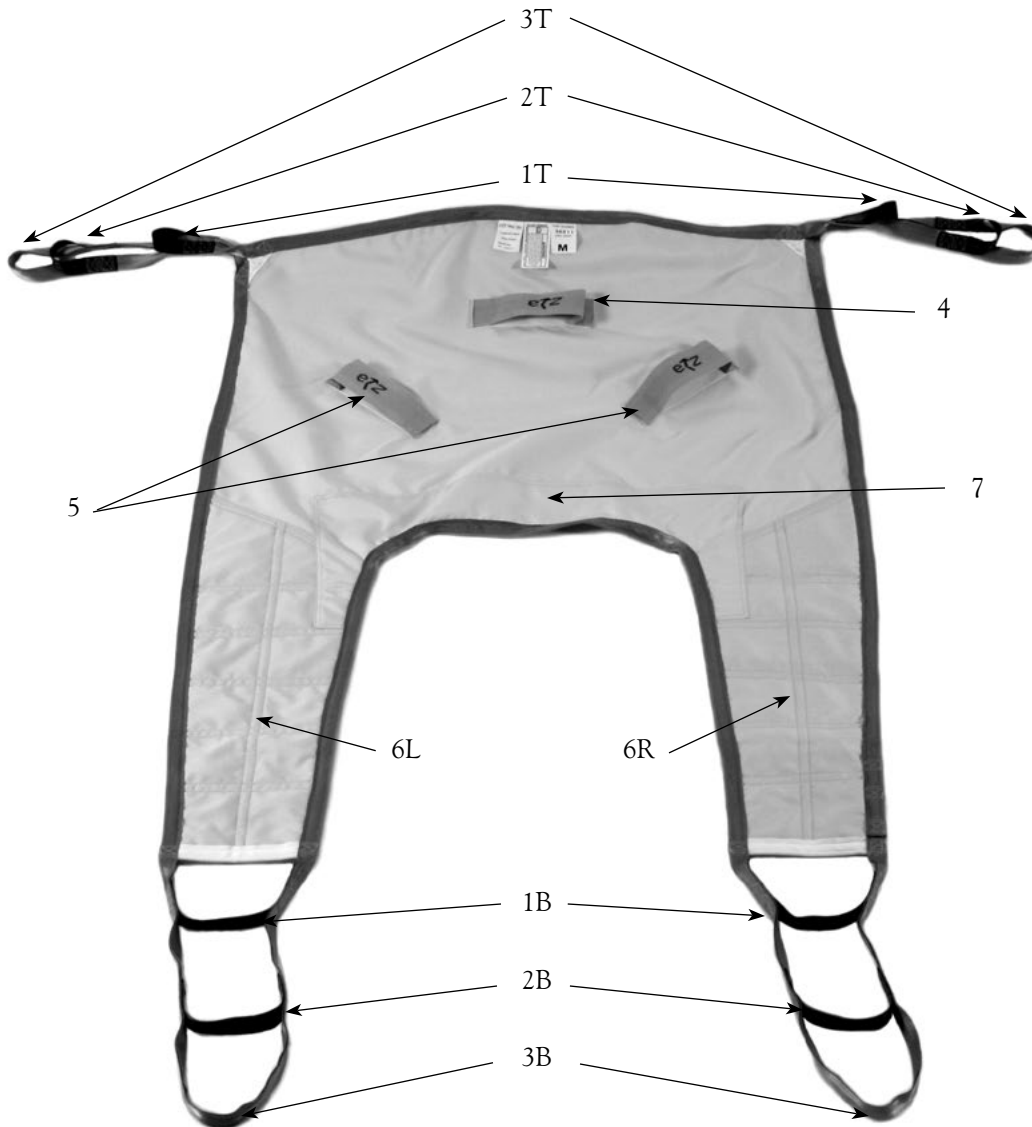

Figure 3 - Hand-Held Remote

## Sling Information and Diagram

EZ Way Slings are designed to be applied or removed with a minimum amount of handling of the patient. As patients do vary in size, shape, weight and temperament, these conditions must be taken into consideration when deciding which EZ Way Sling is suitable for each patient's needs. There are a variety of slings available in various sizes. Please contact EZ Way with any questions regarding sling dimensions and sizes, or view them at [www.ezlifts.com](http://www.ezlifts.com).

We have used the Medium Deluxe Sling throughout the manual because it is the most commonly used sling. Wipeable and disposable slings are also available. To order slings call 1-800-627-8940.



**Figure 4**

1T – 1st Loop (shortest)  
2T – 2nd Loop (middle)  
3T – 3rd Loop (longest)  
4 – Center Handle  
5 – Side Handles  
6L – Left Sling Leg

6R – Right Sling Leg  
7 – Base of Sling  
1B – 1st Loop (shortest)  
2B – 2nd Loop (middle)  
3B – 3rd Loop (longest)

# Transferring Patient from Bed to Chair, Wheelchair, or Toilet

## Step 1

### Position Sling under Patient

- 1) Log roll the patient on his/her side away from you. (See FIG. 5)



**Figure 5 - Log Roll Patient**

- 2) Position the sling so that the handles on the back of the sling are facing the mattress. Tuck half of sling underneath patient.
- 3) Using the center handle (4 on Sling Diagram) as a guide, center the sling on the patient's spine with the base of the sling approximately two inches below the base of the tailbone.
- 4) Log roll patient towards you and pull rest of sling out the other side.
- 5) Lay patient on their back. Make sure the sling is centered underneath the patient.
- 6) Lift patient's left thigh and pull the left sling leg (6L on Sling Diagram) of the sling under patient's thigh. Then place excess wing over the top of the patient's left thigh.
- 7) Repeat above step for right thigh.

## Step 2

### Moving the Lift to the Patient

- 1) Move the EZ Way Ceiling Lift until the spreader hanger bar is centered over the patient's torso.
- 2) Using the Down button, lower the hanger bar so it is positioned a few inches over the body of the patient. The goal is to provide for ease of sling attachment (Step 3). (See FIG. 6)

### Important

Ensure that the lift is directly above patient prior to attaching sling. Do not attach sling if lift is misaligned to the front, back or either side.



**Figure 6 - Moving Lift to Patient**

## Step 3

### Attaching the Sling to the Lift

- 1) Turn hanger bar assembly so it is perpendicular to the patient's torso as shown in Figure 2.
- 2) Take the wing that is lying over the left leg, cross it over and hook it on the hook of the hanger bar located on the right side of the patient.
- 3) Next, take the wing lying over right leg, cross it over and hook it on the hook of the hanger bar located on the left side of the patient using the same length and color of loop strap on each wing. (3B on Sling Diagram)
- 4) Attach the loops to the hanger bar hooks of the lift nearest to each shoulder using the same length and color of loop strap on each side. (See Sling Diagram)
- 5) Make a final check of all four loop attachment points to ensure each loop is sufficiently attached to the respective hook of the hanger bars. Patient is now ready to be lifted. (See FIG. 7)



**Figure 7 - Patient Ready to be Lifted**

#### **Step 4**

##### ***Lifting the Patient***

- 1) Push the UP button on hand control to initiate the upward motion of the hanger bar.
- 2) Continue the upward motion until there is tension on the sling legs, making sure all the loops on the sling are securely hooked on the hanger bars.
- 3) Lift the patient's knee and smooth out the sling under each of the thighs, if necessary.

NOTE: For patients who have soft or delicate skin, care must be taken to ensure the sling is smoothed out along the thigh. There may be instances when patients with extremely fragile skin will require a different sling, such as a multipurpose sling.

- 4) Continue lifting the patient so he/she is just high enough to clear the bed.

#### **Step 5**

##### ***Transferring the Patient***

- 1) Ensure there are no obstructions in the path of travel.
- 2) Depress the appropriate power traverse button on the hand controller if so equipped. For the manual traverse models, push or pull on the sling handles to move the patient.
- 3) Walk with the patient, stabilizing them at the same time to ensure safety.

NOTE: Do not use the hand control as a tether for moving the EZ Way Ceiling Lift.

#### **Step 6**

##### ***Lower Patient into Wheelchair, Toilet or Chair***

- 1) Position the wheelchair under the patient and lock the wheels of the wheelchair. If transferring the patient to a chair or toilet, position the patient over the chair or toilet. Using the handles located on the back of the sling, position the patient so that he/she is properly aligned to be lowered onto the chair, toilet or wheelchair.
- 2) Push the DOWN button on the hand control.

- 3) Stand behind the patient and hold onto the center handle located on the back of the sling. When the patient is nearly seated, gently pull up on the center handle to ensure that the patient will be seated in an upright position. (See FIG. 8)



**Figure 8 - Lowering into Wheelchair**

- 4) When the patient's weight is supported by the wheelchair, chair or toilet, continue lowering the lift to release the tension on the loops.
- 5) Unhook sling from hanger bar and move the lift away from the patient.

#### **Step 7**

##### ***Remove Sling***

- 1) Gently lift the patient's left knee, pulling the sling legs out from underneath the patient's thigh. Continue on right knee.
- 2) Lean patient slightly forward and grasp the side handles or the center handle, pulling the sling out from behind the patient. (See FIG. 9)

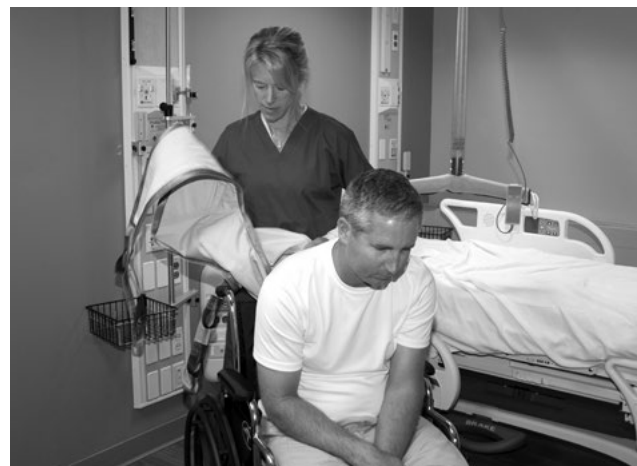

**Figure 9 - Removing the Sling**



# Transferring Patient from Chair, Wheelchair, or Toilet

## Step 1

### Position Sling

- 1) While standing in front of or beside the patient, lean the patient forward several inches to place the sling behind the patient.
- 2) With the sling handles and washing labels toward the chair back, place the sling behind the patient, keeping the center handle of the sling centered on the patient's spine. Make sure the base of the sling touches the chair seat and is two inches below the tailbone. Make sure the top of the sling is above the patient's shoulders and lean the patient back in the chair. (See FIG. 10)



**Figure 10 - Place Sling Behind Patient**

- 3) Pull the legs of the sling along inside of the chair.
- 4) To set the sling properly, you must do the following: On the patient's right side, position your right hand between the patient's hip and the sling. With your fingers, push down on the edge of the sling so that it touches the base of the chair seat. Next, grasp the bottom edge of sling leg with your left hand and pull with a tug towards you.
- 5) Lift the patient's left knee and with a tug, pull the leg of the sling under the hip and thigh.

Place the excess sling length over the left thigh. Repeat this procedure on the right side. This procedure will ensure that the sling is under the patient's tail bone and behind his/her back, with the patient's weight evenly distributed on the sling.

NOTE: Make sure all the seams of the sling are smooth underneath the patient.

## Step 2

### Moving the Lift to the Patient

- 1) Move the EZ Way Ceiling Lift until the spreader hanger bar is centered over the patient's lap.
- 2) Using the Down button, lower the hanger bar so it is level with the patient's forehead and is 10 to 12 inches in front of the patient. The goal is to provide for ease of sling attachment (Step 3).

### Important

Ensure that the lift is directly above patient prior to attaching sling. Do not attach sling if lift is misaligned to the front, back or either side.

## Step 3

### Attach Sling to the Lift

- 1) Turn hanger bar assembly so it is perpendicular to the patient's torso as shown in Figure 11.
- 2) Take the sling leg that is lying over the patient's left thigh and attach it to the right hook on the hanger bar. (See FIG. 11)



**Figure 11 - Attaching the Sling**

- 3) Take the sling leg that is lying over the right thigh and attach to the left hook on the hanger bar, again using the same length and color of loop strap on each side.
- 4) Attach the straps located near the patient's shoulders to the lift hanger bar hooks using the same length and color of loop strap on each side. Example: If you choose the shortest loop on the strap for the right shoulder, you must use the shortest loop on the strap for the left shoulder. (1T on Sling Diagram)



**Figure 12 - Lifting the Patient**

**Step 4**

**Lifting the Patient**

- 1) Push the UP button on the hand control to initiate the upward motion of the lift. Continue the upward motion until there is tension on the wings of the sling, making sure all the loops on the sling are securely hooked on the hanger bars. (See FIG. 12)
- 2) Smooth the sling wings under the patient's thighs with a slight pull on the outside seam of the wings, if necessary.
- 3) Lift the patient to the desired height (usually 2-3" above the chair).

**Step 5**

**Transferring the Patient**

- 1) Ensure there are no obstructions in the path of travel.
- 2) Depress the appropriate power traverse button on the hand controller if so equipped. For the manual traverse models, push or pull on the sling handles.
- 3) Walk with the patient, stabilizing them at the same time to ensure safety.

NOTE: Do not use the hand control as a tether for moving the EZ Way Ceiling Lift.

**Step 6**

**Lower the Patient onto Bed**

- 1) Push the DOWN button on the hand control.
- 2) When the patient's weight is supported by the bed continue lowering the lift to release the tension on the loops. (See FIG. 13)



**Figure 13 - Lowering to Bed**

- 3) Unhook sling from EZ Way Ceiling Lift and move the lift away from the patient.

**Step 7**

**Remove Sling**

- 1) Gently lift the patient's left knee, pulling the sling legs out from underneath the patient's thigh. Continue on right knee.
- 2) To remove the sling from under the patient, gently log roll the patient away from you, folding and tucking the near half of the sling under the patient. Log roll the patient in the opposite direction, allowing you to free the sling from beneath the patient.

**Transferring Patient from Floor**

EZ Way strongly recommends two caregivers complete the transfer when picking a patient up from the floor. Place a pillow under the patient's head. Follow same procedure used when lifting patient from bed (See page 8). Unless using an EZ Way Sling with Head Support, you may want to have a caregiver support the patient's head as he/she is raised, depending on his/her condition. (See FIG. 14)



**Figure 14 - Transferring from Floor**

## Traversing the Lift (Manual Traverse)

To move the lift, use the hanger bar to move the lift along the track. When a patient is in the lift, the operator may prefer to move the lift by placing a hand on the patient's back or hanger bar.

The hand control is not a tether. Do not attempt to move the lift by pulling on the hand control cord.

## Emergency Lowering

In the unlikely event the lift does not operate normally, you may activate the emergency lowering mode by pulling on the red emergency stop cord. First, pull the cord into the emergency stop position. Next, continue pulling on the cord to activate the emergency down mode. This mode will run the motor in the down direction and is independent of the electronics. To stop the down motion, release the cord and it will return to the emergency stop position. Call EZ Way, Inc.'s Service department at 800-627-8940 for assistance.

## Manual Lowering

If the Emergency Lowering procedure above does not function, you may manually lower the lift.

Insert a 1/8" hex key into the small hole on the right side of the motor housing. (See FIG. 15)  
Turn the wrench counter-clockwise to lower the lift. Note: A power driver may be used to lower the lift at normal speed.

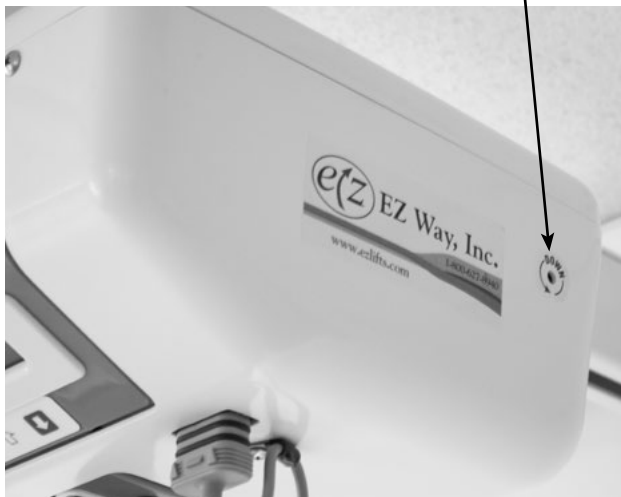

Figure 15 - Manual Down

## Traversing the Lift (Power Traverse)

To move the lift, use the lower buttons on the hand control (See FIG. 16) to move to the right or left.



Figure 16 - Hand Control with Power Traverse

## **Alert Messages**

The EZ Way Ceiling Lift has several built-in safety devices. An alert message is displayed on the LCD display whenever a fault is detected. The following messages may appear during operation of the ceiling lift.

### ***Up Stop***

When the strap is fully retracted, this message will appear. The lift will lower but it will not operate in the up direction. This message may also appear if the lift strap becomes folded or twisted. Simply lower the lift until the strap is unfolded and the lift will then continue to operate normally.

### ***Down Stop***

When the lift strap is fully extended this message will appear. The lift will raise but it will not operate in the down direction.

### ***No Strap Tension***

The lift has a sensor that detects when there is tension on the strap. This prevents the lift from running without tension on the strap. The hanger bar provides enough load to allow normal operation. You may also manually pull on the strap to allow the motor to run until a load is placed on the strap.

### ***Charge Battery***

When the battery level falls to a defined level, this message will appear. The lift will still operate at this time. After your transfer is completed, return the lift to the charging dock to charge the batteries.

### ***Low Battery***

If the lift is used after the Charge Battery message appears, the Low Battery message may appear. At this time, the lift will be able to move in the down direction only. You must charge the lift immediately when this message appears.

### ***Lift Overload***

This message indicates a lift was attempted that was more than the maximum capacity of the lift. The lift will operate in the down direction only when this message is displayed.

## Sling Laundering Instructions

EZ Way slings are designed and manufactured to the highest possible performance specifications. They are constructed of high quality, durable, 100% synthetic fabrics and have been individually inspected before shipping to ensure the safety of the product. However, water washing temperature, detergents and disinfectants, patient incontinence, frequency of use, types and weights of patients, etc., all have an impact on the life expectancy of each product. Because of these factors, the continued integrity of the product is not guaranteed. The user must therefore examine the product to ensure its integrity before each use.

EZ Way warrants that our slings and harnesses will be free from defects in material and workmanship for a period of six months (see Limited Warranty for full description). Slings and harnesses have a life expectancy of up to two years depending on use, care, and proper laundering process. Slings or harness should be discarded and replaced if showing any sign of damage or wear. All slings and harnesses, except for single-patient disposable slings and harnesses, are washable and are capable of bearing a 1,000 lb. weight load, but must only be used to hold the amount of weight dictated by the lift or stand capacity.

Users must accept full responsibility for checking the condition of all slings and harnesses before each and every use on a patient.

To get the longest life out of your product:

- 1) Do not bleach.
- 2) To prevent stains from setting, rinse 5 minutes in 80° – 100° F. Stains will set when temperature is over 105° F.
- 3) Washing temp. 160° F. maximum.
- 4) RINSE THOROUGHLY in 100° F. If high alkaline detergent (with pH greater than 11.0) is used, rinse twice.
- 5) Tumble dry, temperature 100° F. maximum. High heat will weaken the fabric.
- 6) Snap the buckle together before washing and drying. This will prevent any damage to the plastic buckle.
- 7) If available, use a laundry bag to wash and dry the harness.

**Note: Wipeable sling and harness cleaning instructions are packaged with each sling/harness or they are available via the EZ Way website [www.ezlifts.com](http://www.ezlifts.com).**

## Charging the EZ Way Ceiling Lift Battery - Manual Traverse

To charge the EZ Way Ceiling Lift, the unit must be returned to the charging dock. The charging dock is installed at the end of the ceiling lift track. Move the lift backwards until the unit contacts the charging dock. (See FIG. 17) The display will read “Charging”. When the battery is fully charged, the display will change to “Charge Complete” for a short time and then it will return to the battery level screen.

The unit may turn off during the charge cycle. This will not stop the unit from charging.

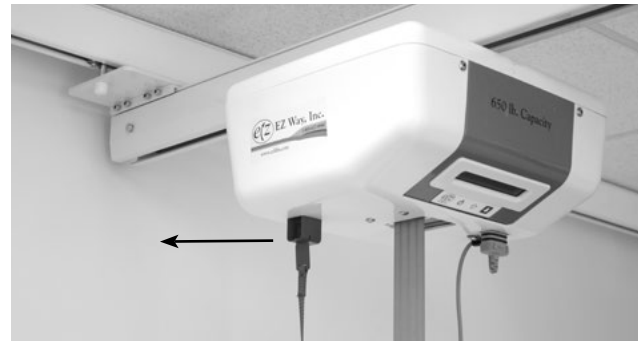

Figure 17 - Return to Charge

## Charging the EZ Way Ceiling Lift Battery - Power Traverse

To charge the EZ Way Ceiling Lift, the unit must be returned to the charging dock. Press the RTC button on the hand control. (FIG. 18). The belt will raise up to the motor initializing the up stop. The motor will then automatically return to the charging dock. Once docked, the belt will lower 3 inches. This signals that the motor is properly docked and charging. For XY gantry systems, you must ensure that the moving rail is aligned to the docking station so the motor connects to the charging dock. The display will read “Charging.” When the battery is fully charged, the display will read “Charge Complete” for a short time and then it will return to the battery level screen.

Note; The unit may turn off during the charge cycle. This will not stop the unit from charging.



Figure 18 - RTC Button on Hand Control



EZ Way, Inc.

# EZ Way Fixed Motor Ceiling Lift Safety & Maintenance Checklist

## EZ Way Ceiling Lift Safety & Maintenance Checklist

The EZ Way Ceiling Lift was designed to safely operate throughout its life with a minimum amount of service. EZ Way recommends the following items be checked periodically to ensure safe operation of the lift.

The manufacturer suggests that the following components and operating points be scheduled for inspection at intervals not greater than one year. Any detected deficiency must be rectified before the lift is put back into service.

- 1) Inspect ceiling-mounted track.
  - a) Track should be secure and not move in any direction.
  - b) Check that end stops are securely in place at all track ends. (See FIG. 19 & 20)
  - c) Check each mounting bracket for loose screws. (See FIG. 21)
  - d) Check all track accessories, gates, and turntables for proper operation.



Figure 19 - End Stop



Figure 20 - End Stop 2



Figure 21 - Mounting Bracket

- 2) Inspect the hanger bar. All fasteners and pins should be in place and secure. Inspect spiral rings on pins. (See FIG. 22)
- 3) Check lift strap for signs of wear or loose stitching. If the strap shows signs of wear anywhere along its length it should be tagged for further inspection and possible strap replacement.
- 4) Check all controls for proper function. Operate the lift in the up and down modes using the hand control as well as the buttons on the control panel.
- 5) Check Safety Interlocks:
  - a) Up Stop: Using the up key, retract the lift strap all the way into the motor. When the strap is fully retracted the display should read "Up Stop".
  - b) Down Stop: Using the down key, extend the lift strap all the way out. When the strap is fully extended the display should read "Down Stop".

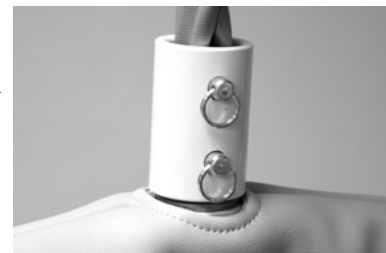
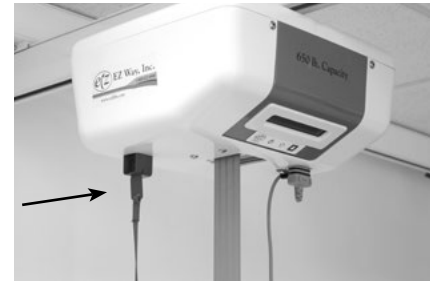

Figure 22 - Spiral Rings

- c) Emergency Stop: Pull on the red strap. (See FIG. 23) The display should read “Emergency Stop”. The unit will not operate while the emergency stop is activated. To reset the Emergency Stop switch, push the red button in to the run position.
- d) Emergency Down: To activate the Emergency Down function, pull the red strap past the Emergency Stop position. The motor will run in the down direction. To stop movement, release the strap and it will return to the Emergency Stop position. **WARNING**, do not continue to use the Emergency Down function after the strap has been lowered.



**Figure 23 - Emergency Stop**

- 6) Annual Load Testing:**
  - a) Attach a load equivalent to the capacity of the lift.
  - b) With the unit under load, operate the lift in both the up and down directions. The lift should operate smoothly and quietly. If any excessive noise is heard call EZ Way Service at 800-627-8940.
  - c) Move the load along the track so it travels the entire length of track.
  - d) Observe the track and watch for deflection. For tracks mounted to the ceiling, the track should not deflect more than 1/8”.
  - e) If the system has a moveable gantry track (H-system), the moving track may deflect as much as 3/4” under full load.
  - f) Check each end of the track to make sure the end stop is securely in place.
  - g) With no load on the track, attempt to move the track side to side. A properly installed track should have little or no movement.
  - h) Each mounting bracket has a screw which should be checked for tightness. Do not overtighten these screws.
- 7) For manual charging models, return motor to its charging location. Let motor sit idle on continuous charge track. The display should read “Charging”. The number that is displayed indicates the amount of charge the batteries are taking. When the battery is fully charged the display will return to the battery gauge.

---



---

**IMPORTANT NOTICE**

It is the responsibility of the purchaser to ensure that regular maintenance inspection is conducted on this device by competent staff.

**DATE COMPLETED:** \_\_\_\_\_

**COMPLETED BY:** \_\_\_\_\_

**PASS / FAIL:** \_\_\_\_\_

**MODEL & SERIAL NO.:** \_\_\_\_\_

**EQUIPMENT PURCHASE DATE:** \_\_\_\_\_

# Customer Settings Summary Sheet

## Guide to main functions and keys

Menu list	Description
Inspection Reminder	Enable/disable, occurs every 30 days
Inspection Complete	Resets 30-day counter
Motor Minutes	Motor usage counter, should be reset upon motor replacement
Lift Total Minutes	Stand/Lift usage counter in minutes

## Navigating Through Menus Key

Menu list	Description
Scrolling to change menu item	UP/DOWN Keys
Key to enter data	Up on hand control
Key to exit menu	Down on hand control

Main functions	Key combination
ON/OFF	Turns unit on and off
Customer Settings Menu	DOWN + UP – hold 5 seconds
UP	Used to raise the EZ Way Ceiling Lift
DOWN	Used to lower the EZ Way Ceiling Lift

## Diagnostic Messaging

### Motor Overload

When a motor overload occurs the EZ Way Ceiling Lift computer records the event to protect the unit's components, and an 'MOTOR OVERLOAD' message will display. An event count is stored in the Customer Settings menu under 'Motor Overload Counts'. This read-only count can be accessed at any time. Possible causes of motor overload include:

- Lifting a patient that is heavier than the rated capacity
- Ceiling Lift is obstructed
- Mechanical Failure

In the event of a motor overload, the EZ Way Ceiling Lift will only operate in the DOWN direction.

When the motor overload count is greater than 4, a fault message will display when the unit is turned on, reading 'MOTOR OVERLOAD...CALL EZ WAY SERVICE'. When this message appears call the EZ Way Service Department at 1-800-627-8940.



## Duty Cycle Fault – Helping to Protect EZ Way Ceiling Lift Motor

In the unlikely event the EZ Way Ceiling Lift has been run to the extent that it exceeds its duty cycle, the following message will appear; ‘MOTOR DUTY CYCLE FAULT...COOLING’.

When this fault occurs the lift can only be lowered. This safety feature has been added to maximize the life of your unit.

## LCD Display Menus

EZ Way Ceiling Lifts include a built-in menu system that provides customer feedback on various functions. The information below describes how to access and navigate through the Customer Settings menu.

**NOTE:** In this section, the UP and DOWN operations refer specifically to usage of the front panel UP and DOWN buttons.

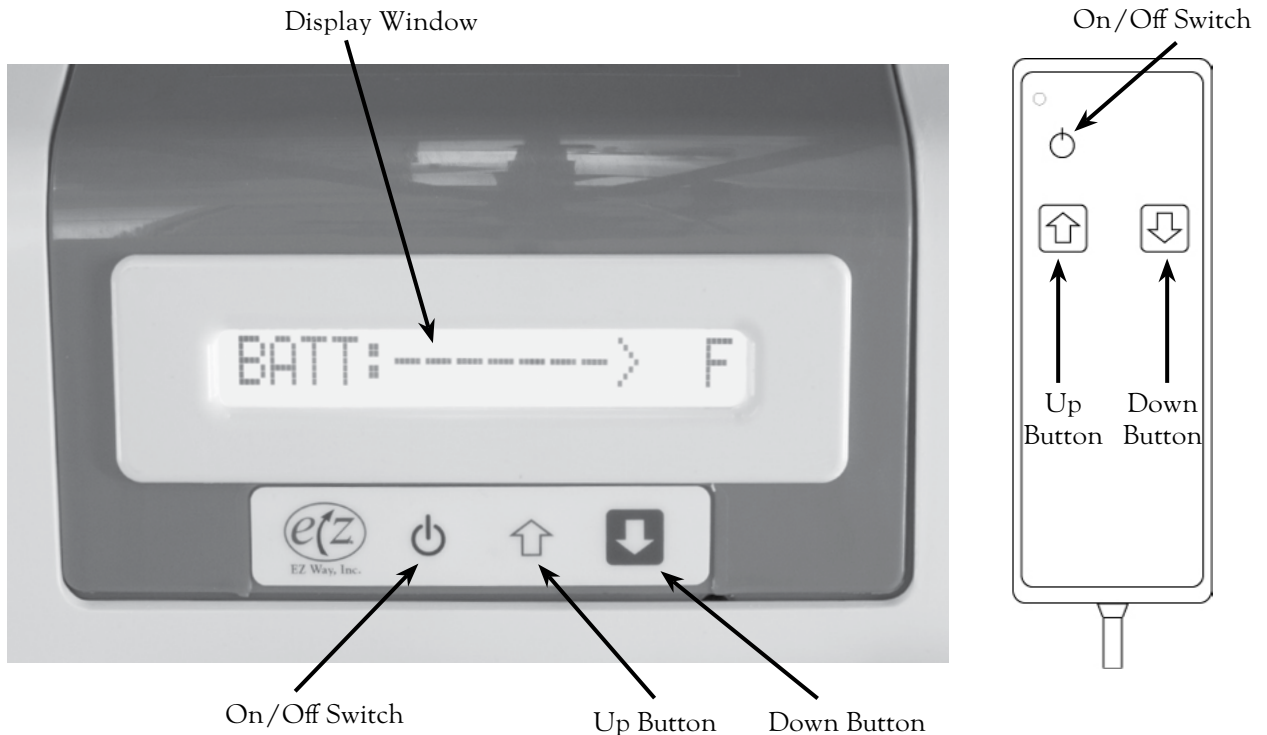

**NOTE:** The EZ Way Ceiling Lift will not raise or lower while in the Customer Settings menu.

### Entering the Customer Settings Menu

After the unit has been turned on, press and hold the DOWN key followed by the UP key, holding both keys for 5 seconds.

To exit the Customer Settings menu, press the down button on the hand control.

### Navigating through Menus

- 1) Pressing the UP or DOWN front panel keys will allow users to move through the menu items (also described as ‘scrolling’ below).
- 2) Pressing the up button on the hand control (also described as ‘enter’ below) will enter into a menu selection.
- 3) Pressing the down button on the hand control (also described as ‘exit’ below) key will exit the menu selection.

### Changing Parameter Values

- 1) Pressing the UP or DOWN front panel keys will change various parameters found in the Customer Settings menu.
- 2) Pressing the up button on the hand control will lock the parameter into memory.
- 3) Pressing the down button on the hand control will back out of the parameter without saving the selection.

## CUSTOMER SETTINGS MENU FUNCTIONS

Within the Customer Settings menu there are several functions that provide customer feedback. The functions include an optional inspection reminder, lift usage measured in minutes, and diagnostic information. Below is a description of each function.

### **Inspection Reminder – Optional**

The Inspection Reminder function tracks the last inspection occurrence. When the duration of time since the last inspection exceeds 30 days, a reminder message will appear when the unit is turned on. The purpose of the inspection reminder is to notify the user that the EZ Way Ceiling Lift needs to be inspected using the EZ Way Safety & Maintenance Checklist form included on pages 13 - 14. When the inspection is complete the reminder can be reset in the Customer Settings menu as described below:

- 1) To enable/disable the Inspection Reminder enter the Customer Settings menu as described on page 13.
- 2) Press the right toggle switch to enter.
- 3) Scroll to Inspection Reminder using the UP and DOWN keys on the controls.
- 4) Press the right toggle switch to enter.
- 5) Scroll to choose Yes or No.
- 6) Press the right toggle switch to enter.
- 7) Press the left toggle switch twice to exit.

### **Inspection Complete**

If 'INSPECTION OVERDUE' appears when the EZ Way Ceiling Lift is turned on, inspect the unit following the EZ Way Safety & Maintenance Checklist'. The EZ Way Ceiling Lift will continue to operate normally.

Once inspection is complete, enter the Customer Settings Menu as described on page 13.

- 1) Press the up button on the hand control to enter.
- 2) Scroll using the UP and DOWN keys to Inspection Complete.
- 3) Press the up button on the hand control to enter.
- 4) Scroll to choose Yes.
- 5) Press the up button on the hand control to enter.
- 6) Press the down button on the hand control to exit.

### **Lift Minutes**

The Lift Minutes function tracks the accumulated amount of raising and lowering time of the lift by the minute. With each minute of runtime, the Lift Minutes register increments by one. This read-only information provides accurate customer feedback of EZ Way Ceiling Lift usage within the facility and can be a valuable tool in monitoring a safe patient handling program. In the event of a lift replacement the Lift Minutes register can be reset.

### **Lift Overload Counts**

The Lift Overload Counts function tracks any lift overload occurrences. When a lift overload occurs, the Lift Overload Counts register increments by one. Potential causes of a lift overload include accidental lifting of the EZ Way Ceiling Lift against an obstruction, lifting a patient that is heavier than the rated capacity of the unit, or mechanical failure (internal gear binding).

### **Lift Total Minute Usage Count**

The Lift Total Minutes function tracks the accumulated amount of raising and lowering time of the unit. This read-only information provides accurate customer feedback of EZ Way Ceiling Lift usage for the entire life of the unit.

# EZ Way Ceiling Lift Competency Checklist

Purpose: To assist in the proper training of operating the EZ Way Ceiling Lift.

Staff Name: \_\_\_\_\_ Date: \_\_\_\_\_ Observed by: \_\_\_\_\_

Yes No

## 1. EZ Way Ceiling Lift Pre-Operation Check

- a) Demonstrate how to turn EZ Ceiling Lift on/off.
- b) Demonstrate how and when to change batteries.
- c) What are the 2 different methods to raise/lower the resident/patient?
- d) Locate emergency stop button and state its purpose.
- e) Locate safety down feature.
- f) Examine sling for any sign of wear/tear.
- g) Identify where charger is located (fixed motor or portable motor).

## 2. EZ Way Ceiling Lift Sling Usage

- a) Demonstrate proper fitting of sling to resident/patient.
- b) Demonstrate proper application of sling.
- c) Do you cross the legs of the sling when attaching it to the lift?
- d) Explain the different loops and their usage for positioning.
- e) Demonstrate proper attachment of sling to lift.
- f) What are the 3 handles on the back of the sling used for?
- g) Demonstrate proper removal of sling from underneath resident/patient.

## 3. EZ Way Ceiling Lift Operation

- a) Where should the hangar bars be located when attaching the sling to the unit?

For any questions or concerns, please refer to the EZ Way Ceiling Lift operator's manual or training video.

ANSWERS: 1a) Use the power button located on control panel or by pushing the up or down button on the hand control. 1b) Charge when the lift is not in use. The LCD will read charge battery when the batteries become discharged. 1c) Using buttons on hand or up/down buttons on face of control panel. 1d) Fixed motor: Red cord descending from the motor – used to disengage the motor. Portable motor: The red emergency stop button on the top of the motor instantly cuts power to the motor. 1e) Fixed motor: Pull the red strap hanging from the motor past the Emergency Stop Position to activate Emergency Down. If power is lost, insert 1/8" hex key into the hole on side of the lift and manually lower turning wrench counter-clockwise. Portable motor: Push the red button on top of the motor past the Emergency Stop Position to activate Emergency Down. If power is lost, insert 1/8" hex key into the hole on side of the lift and manually lower turning wrench counter-clockwise. 1f) Look for intact stitching & seams; Look for fraying or ripped into the hole on side of the lift and manually lower turning wrench counter-clockwise. 1g) Fixed motor: Charging station is built into the end of the ceiling track. Portable motor: Charger adapter plugs into front panel of motor. 2a) At a minimum, top of sling to top of "horseshoe" portion of sling should run vertically, place sling on bed so handles are touching the bed & center fold is near center of the bed-where patient's spine will be; top of sling should align with neck line and bottom of sling body should be 2-inches below tailbone. Tuck top half of sling near patient. Roll patient to other side, pull top half of sling under patient leg on same side, pulling leg strap up between legs. Repeat other side. 2c) Crossing legs is the safest procedure. Multi-purpose sling may be used to cradle legs instead of threading straps between legs to cross. Caregiver must assess condition of patient to determine if this is appropriate. 2d) Leg loops: Shorter loops recline patient further; longer loops place body in upright sitting position. Shoulder loops: Longer loops recline patient; shorter loops place in upright sitting position. 2e) Once sling is applied underneath a patient, attach two loops of same color nearest the head and shoulders to the hangar bar hooks closest to the head. Once legs of sling have been fitted underneath legs and crossed, attach two loops of same color to the hangar bar hooks located nearest the feet. Ensure all loops securely fastened to hooks before lifting. 2f) Straps are for guiding patient and rotating patient while suspended; Also helps with upright seated positioning when the middle strap is held stationary, just prior to seating patient. 2g) If supine, log roll patient to one side folding half of sling and tuck under patient. Roll patient in other direction and remove entire sling from under patient. If seated, gently pull legs of sling from under patient's legs placing sling legs to side of patient. Grasp middle handle and gently pull upward, removing sling from behind patient. 3a) Motor, strap and hangar assembly should be located directly above patient – centered over sternum when in supine position.



EZ Way, Inc.

EZ Way, Inc.  
PO Box 89  
Clarinda, IA 51632  
1-800-627-8940  
[www.ezlifts.com](http://www.ezlifts.com)



[www.ezlifts.com](http://www.ezlifts.com)



Fixed Ceiling Lift  
Training Videos

