



EZ Way, Inc.

“Your Total Patient Lift Solution”

Dignity Bariatric Operator’s Instructions



EZ Way, Inc.
PO Box 89
Clarinda, IA 51632
1-800-627-8940
www.ezlifts.com

⚠WARNING: Cancer and Reproductive Harm - www.P65Warnings.ca.gov.

Form 2-272
Rev. 07/30/18

Product Description



Chair Picture Shows

A	Backrest
B	Armrest (swivelling)
C	Locking Pins
D	Chair Frame
E	PUR seat with Hygiene opening
K	PUR Seat Cushion (removable)
N	Wheel complete with Brake
P	Footrest with Foot-plate (adjustable)
V	Commode Pan with Lid
Z	Nameplate for Product

Table of Content

1.	General Suggestions	3
1.1	Introduction	3
1.2	Symbols	3
1.3	Intended Proper Use	3
1.4	Use and Storage	3
1.5	Features	3
2	Warranty	3
3	Nameplate / Ordering Replacement Parts	4
4	Safety Advisories, Use	4
5	Product Specifications	5
5.1	Scope of Delivery	5
5.2	Technical Specifications	5
6	Spare Parts & Accessories	6
7	Setting up the Chair for Use	6
8	Using the Chair	6
8.1	Sitting Down	6
8.2	Getting up	7
8.3	Swivelling the Armrests Outwards	7
8.4	Adjusting the Footrest Height	7
8.5	Folding the Footrests	7
8.6	Removing the Footrests	7
8.7	Removing the Seat	7
8.8	Removing the Back Cushion	7
8.9	Using the Wheel Lock	7
8.10	Handling the Commode Pan	7
8.11	Rolling over the Toilet	7
9	Troubleshooting	8
10	Care	9
11	Maintenance, Repair	9







1. General Suggestions

1.1 Introduction

In this manual you will find information on safe and proper installation, use, operation, maintenance and care of the chair.

Read these operating instructions carefully before using the product. Note, in particular, the safety instructions and act accordingly.

1.2 Symbols

	Read the User Manual!
	Product Conforms to the “Medical Products Directive 93/42/EEC”
	Danger – Follow Safety Instructions!
	Caution! Suggestion
	Information!
	Care
	Maintenance

1.3 Intended proper use

The shower/commode chair is for homecare and institutional purposes. The chair is to be used exclusively for assistance during showering or bathing, using a toilet or for transfer of persons inside buildings. The shower/commode chair is not designed for long periods of sitting.

1.4 Use and storage



Watch out! Risk of damage

The operating temperature of the product should be between **40° and 105° Fahrenheit**. Store the product in a dry place at a temperature between **0 to +40°** and humidity of **30-55%**. Outside these conditions, the product could be used only shortly. Do not store the product near heat sources. Avoid direct sunlight on the product.

The chair is not suitable for use in saunas and areas with swimming pool-like condition as surface discoloration and adverse effects on the mechanical strength may occur.

1.5 Features

The chair is made of a corrosion-resistant frame and four rubber-wheeled castors with locking brakes for the back castors. The armrests can be swivelled outward / backward.

The footrests are height-adjustable and can be removed and folded away. The chair can be rolled over a conventional bathroom toilet.

Use as a Shower chair

The chair may be used where the use of or access to a conventional shower or bathtub is no longer possible due to a patient’s physical limitations. The shower must be designed so that the chair can be rolled into it unhindered.

Use as a Commode chair

The chair may be used where the use of or access to a conventional toilet is no longer possible due to a patient’s physical limitations. The seat surface has a toilet-like cut-out where a commode pan can be inserted.

2. Warranty

The product has a warranty of 5 years, when noticing/respecting our general terms and conditions and the intended use of the product. Unauthorized changes made to the product without the consent of the manufacturer will void the warranty.

3. Nameplate / Ordering

Replacement parts

On the nameplate you can find the following important information:

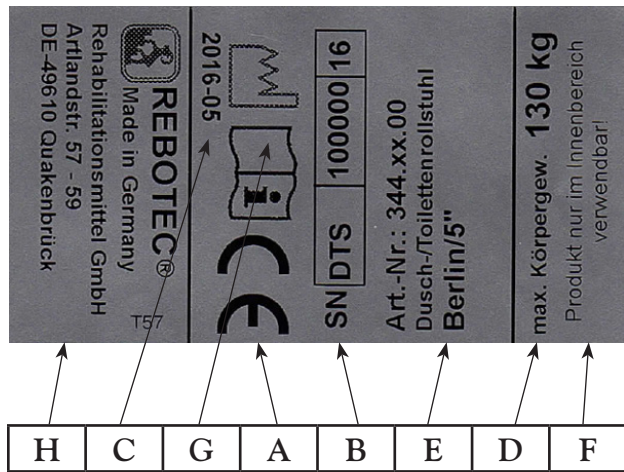

A	Mark of Conformity (CE)
B	Serial Number-Product
C	Production Year
D	Max. Body Weight
E	Product Name
F	Note (use)
G	Read User Manual
H	Manufacturer Details

The nameplate is very important for product identification, and thus must not be removed.



To help identify what spare parts are needed, it is necessary to provide the product name, serial number (SN) and the product's year of manufacture.

4. Safety instructions for use



When using the chair, the following safety instructions must be observed:

Warning! Danger of Slipping!

- Before using, check to be sure the seat is securely pressed into the seat frame.
- Always lock the swivel castors before using the chair. This is to prevent the chair from rolling away.
- When sitting down into the chair, the user must not sit on the front edge of the seat or seat cushion. Be sure the user sits all the way back on the seat.

Warning! Danger of Tipping Over!

- The chair may be used only when the armrests are locked into position, when sitting and when rolling.
- The chair may only be pushed by using the backrest.
- The footrests must be swivelled away or folded up whenever the patient sits down or gets up. The patient must never attempt to stand on the footrests!
- The chair must not bump into door sills, jambs or be used on uneven surfaces.
- Only use the chair indoors and on solid, even, non-slippery surfaces.
- The chair may only be pushed at a walking speed or less (with or without the patient).
- Do not lean out of the chair when the chair is still or in motion. If the swivel castors are swivelled inwards, then the stability of the chair is decreased.

Warning! Danger of Breakage!

- The chair only is suitable for transporting persons and for patient care as instructed in this manual. Be sure to observe the maximum allowable patient body weight (specified on the nameplate).
- Never attempt to carry or lift the chair while a patient is sitting in it.
- Do not grab hold of or pull on attached objects, such as IV Pole, armrest cushions.

Warning! Danger of Pinching!

- To prevent body parts or objects from getting pinched, never reach into the hinge area when turning the armrests up or down. Be sure to check that the hinge areas are unobstructed before moving the armrests.
- To prevent body parts from getting pinched, do not reach between the seat and the frame when pressing the seat into the seat frame.
- Be sure other parts do not get jammed when folding and unfolding the footrests.

Warning! Danger of Falling!

- Sitting down, standing up and moving the patient should be supervised by a qualified caregiver who understands the health condition of the patient.
- Use of the chair by patients who do not have complete physical control and normal movement must not be done unsupervised.
- Rolling the chair on any sloped surface may be done only with the assistance of a caregiver.

Warning! Danger of Injury!

- At surface temperatures over 104° Fahrenheit, there's a risk of injury. Do not expose the chair to any source of heat such as exposure to the sun, storing near a heater, cleaning with hot water just before the chair is used. Before using the chair, allow it to cool down.
- Before using the chair from patients with insentive skin (persons who can't feel any increase of temperature and /or with skin damage) the caregiver has to make a thermal check of the surface with the back of the hand.
- Observe the instructions of use (see 1.4).

5. Product Specifications

5.1 Scope of delivery

The product has been carefully inspected in the factory for freedom of defects and for completeness. After having received it, carefully check over the product for possible transport damages and for completeness.

- 1 shower / Commode Wheel Chair
- 1 Back-rest
- 1 Seat
- 1 commode pan with lid
- 1 User Manual
- Accessories (optional)

5.2. Technical specifications

We reserve the right to make technical developments and improvements with respect to

the design shown in the User Manual.

Dimensions (ca.)	Dignity Classic Bariatric
A. Height	40.9 inch
B. Width	29.1 inch
C. Depth	35.4 inch
D. Seat Height	22.0 inch
E. Seat Width	25.2 inch
F. Seat Depth	18.9 inch
G1. Clearance*	17.5 inch
G2 Clearance*	18.7 inch
H. Foot Height	14.9 - 20.9 inch
I. Wheel 5"	4.9 inch
Body Weight Max.	441 lbs.
Product Weight**	48.5 lbs.

* Clearance: G1 = with pan receptacle

G2 = without receptacle

** Product weight without accessories

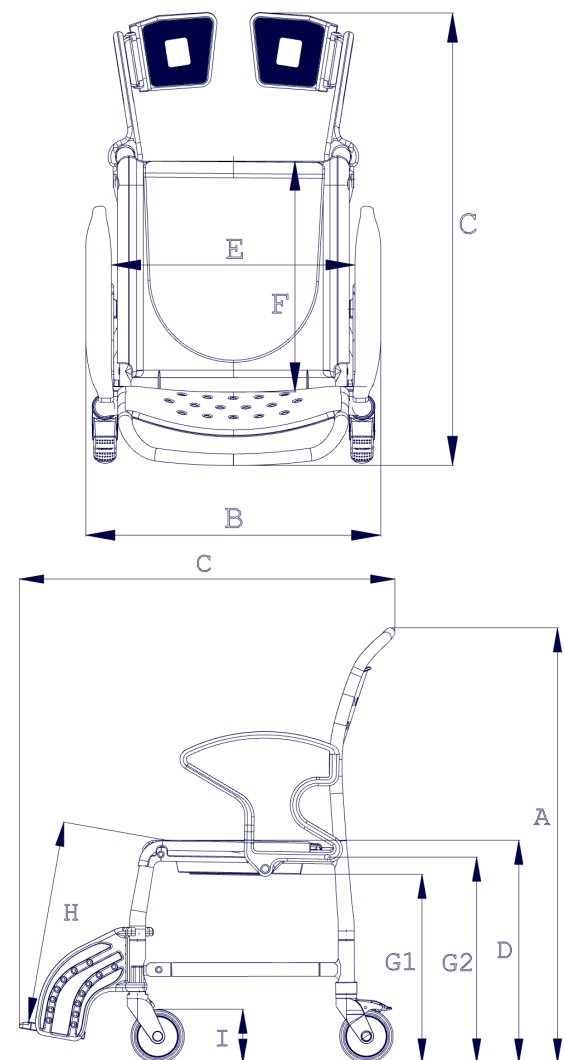

6. Spare parts & Accessories

Article No.	Name
Spare Part	
30100	Commode Pan with Lid
3223010	Arm Locking Pin
4401022	Seat with Opening
4401012	Seat Cushion
4451059	Back Cushion
44050020	Stabilization Brace for Dignity Classic Bariatric
20128	2 Clips for Stabilization Brace
11.07.080	User Manual

7. Setting up the chair for use

The product is delivered partially pre-assembled.

The following assembly instructions must be carried out before first-time use:

1. Turn the footrests forward until they click into position. Then unfold the foot supports downward. Finally adjust the height of the footrests (see: 8.4).

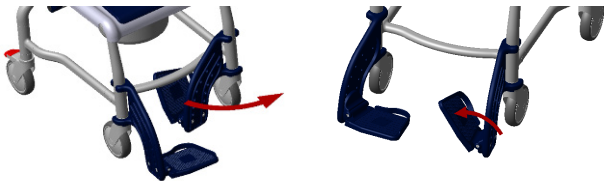

2. Swivel the armrests to the back, insert the backrest into the steel tubes of the chair frame and push it down until it hits the striker of the lower frame.

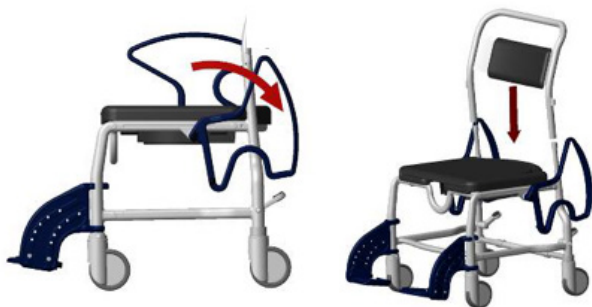

3. Swivel the armrests forward until they reach the slot of the backrest and click into the locking pins of the lower frame.



4. The back wheels are always locked for delivery. Lift up the locking levers to release the wheels.



8. Using the chair

When using the chair, the following points must be adhered to:



Before use, it must be assured that the chair is in a proper condition for safe use. If necessary, depending on the physical and strength limitations of the patient including their ability to move and muscle strength, sitting down and getting up should not be done without assistance from a caregiver. The chair may not be used for long patient transport times.

8.1 Sitting down

Before sitting down in the chair, be sure it is secured against slipping away (see: 9.9) and tipping over, that the armrests are locked into position, that the shower/commode seat is properly mounted, and that the footrests are folded away to the side or folded up.

1



The patient must stand as close as possible to the chair, then sit down slowly on the whole seat during

supporting themselves with using both armrests. If this is not possible due to their physical limitations, then a caregiver must assist them. If necessary a patient lift or stand may be used.

2



Caution – Danger of Falling!

To prevent the patient from falling out of the chair, be sure the patient is seated completely on the chair, and not just on the edge.

For transporting the patient, be sure they are leaned back against the seat back and be sure they use the footrests.

8.2 Getting up

Before getting up, be sure the chair is stable and secured against slipping away (see 8.9) and tipping over, that the armrests are locked in position, and the footrests are folded away to the side or folded up. The patient should then move his body forward until his feet are flat on the floor.

3



The patient must then place both hands on the armrests and slowly lift themselves up.

The patient must not lean too far forwards to avoid falling. The patient should have the caregiver assist them when getting up.

4



Caution – Danger of Falling!

The patient must not stand on the footrests when getting up or leaving the chair.

8.3 Swivelling the Armrests Outward

By pulling out the locking pin, the locking mechanism is disengaged and the armrests may be swivelled back. When swivelling the armrests up, check to be sure that the armrests are properly seated in the locking position of the backrest and locked by the locking pin.



Check the locking mechanism on a regular basis for impaired function arising from calcium deposits, which can impair movement.

8.4 Adjusting the Footrest Height

The footrests are height-adjustable in stages. To do this, unscrew the screws of the footrests on the side using an SW6 Allen key.

Select the appropriate height and tighten the screws of the footrest. Be sure the screw is securely tightened.

8.5 Folding away the Footrests

Swivel the footplates upward and lift the footrests. The footrests can now be swivelled back to the side.

8.6 Removing the Footrests

Lift the footrests approximately 4 inches and turn them outwards 90°. Now you can lift the footrests up and remove them.

8.7 Removing the Seat

The seat can be removed from its receptacles for the purpose of cleaning or exchanging by simply pulling it up.

8.8 Removing the Back Cushion

The back cushion is fastened to the cross-brace or backrest with studs. Press the buttons to remove the back cushion.

8.9 Using the Wheel Locks

To lock the wheels, press the locking levers down with your foot. Releasing the wheels is done by lifting up the locking levers.

8.10 Handling the Commode Pan

Push the commode pan under the seat from behind the chair. To remove the pan, lift it up slightly and pull it out.

8.11 Rolling over a Toilet

After removing the stabilization brace, the chair can be rolled over a toilet.



Caution – Safety Advisory!

Transporting a patient without an installed brace is not allowed because of safety reasons. After the toilet is used, the brace absolutely must be re-installed!

Step 1

Before disassembling brace (A), lock both rear wheels with both wheel locks (B) (see: 8.9).

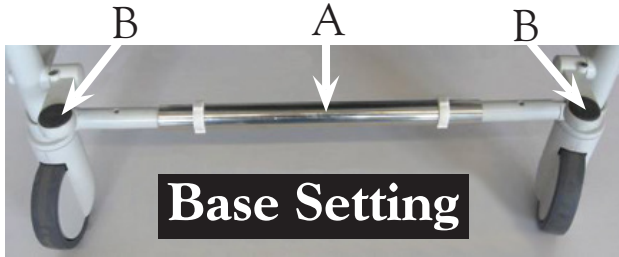

Step 2

Pull out the 2 clips (C) from the brace.



Step 3

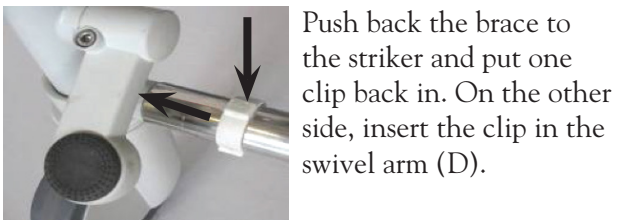

Push back the brace to the striker and put one clip back in. On the other side, insert the clip in the swivel arm (D).

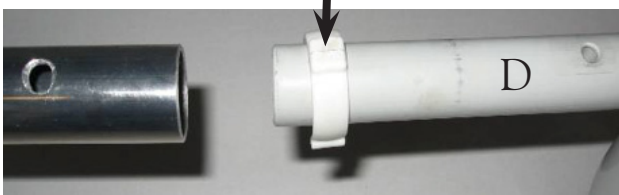

Step 4

Swing out both swivel arms of the brace toward the inside of the chair so that it can be rolled over the toilet. Release the wheel brake locks.

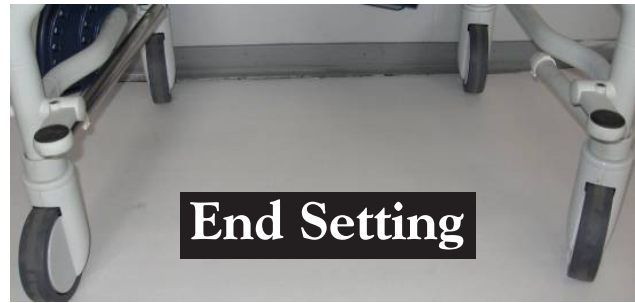
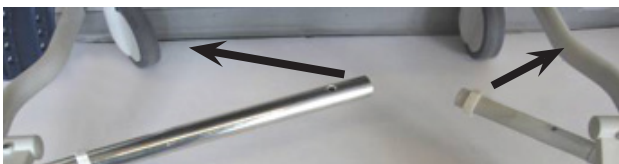

Step 5

After toilet use is finished, lock the two rear wheels once again and install the stabilization brace following the process in reverse.



Use the chair only when it is in the base setting.

9. Troubleshooting

Fault	Possible Cause	Correction
Armrests do not swivel properly	Locking pins are caked with deposits	Clean, check periodically
Locking pins cannot be pulled out	Caked up, tension spring is jammed or defective	Clean, replace locking pin
Footrests do not swivel properly	Caked up joints, jamming	Clean, check screw connection
Castor wheels do not lock	Generally defective	See Section Maintenance
Wheel turns with difficulty	Deposit build-up	Clean
Wheel does not rotate	Generally defective	See section on Maintenance
Wheel do not Rotate	Generally defective	See section on Maintenance
Wheels no longer round	Wheels unevenly worn	See section on Maintenance
Chair frame too unstable	Screws are loose	Tighten frame and castor screws
Castors are bent	Bumped into objects	See section on Maintenance

10. Care



In general the chair can be cleaned using a mild conventional cleaning and disinfecting agent. Simply wipe the chair with clean water and cloth, and then wipe dry with a clean cloth.

Do not use an abrasive scouring agent or cleaners that contain aggressive solvents such as acids or thinners. Do not use stiff cleaning brushes, as these will damage the plastic surfaces or cause deposits to build up on the plastic parts and other materials.



Keep the product clean and clean it at regular intervals. In the sensitive areas hygiene is very important.

11. Maintenance, Repair

The cause of accidents or damage may be due to the late detection of wear and/or improper use, as well as irregular or lack of maintenance.



For safety reasons and to prevent accidents, the chair must undergo complete maintenance at least once a year.



Maintenance

Periodic safety-related controls are needed:

- Check for apparent damage (cracks, fractures, loose parts).
- Check screwed connections for tightness (especially the castor wheels and the frame).
- Check the function of the armrests and locking pins.
- Check the function of the footrests (replace defective footrests).
- Check the function of the wheels and rolling ability and replace defective wheels.
- Check accessories for defects.



Repair

- If you have questions concerning maintenance and repairs to the chair, contact EZ Way's Service Department at 1-800-627-8940.
- When making repairs, use only original replacement parts from EZ Way. Observe all advisories concerning guarantee and warranty.
- Never make any unauthorized modifications or changes to the chair. These will only adversely affect the safety and function of the chair. In such cases EZ Way assumes no liability.
- Follow all the instructions when ordering replacement parts, re-use and product lifetime of the chair.
- After a complete maintenance or repair of the chair is done, we recommend a complete cleaning for assuring proper hygiene. Follow the cleaning instructions.



You can download the User Manual via our website at www.ezlifts.com. It is possible to print out the information.

WARRANTY, CE MARK & TECHNICAL SPECIFICATIONS:

EZ Way Dignity Bariatric

Warranty: EZ Way warrants that its products are free from defects in materials and workmanship for a period of 5 years from the date of delivery on the frame & 2 years on components. This warranty is in lieu of any other warranty or representation, expressed or implied. Warranties of MERCHANTABILITY or FITNESS FOR ANY PARTICULAR USE OR PURPOSE are expressly excluded. EZ Way will not be responsible for any expenses, inconvenience or incidental or consequential damages occasioned by the use, loss of use, or misuse of the products, or by the failure of the products to conform to the warranty set forth above. This warranty becomes void if the product shows evidence of mishandling, tampering, installation or use contrary to the applicable instruction materials, shipping damage, or repair. Routine cleaning, adjustment, and normal cosmetic and mechanical wear are not covered by this warranty.



CE mark: Certificate of registration at the LÄKEMEDELSVERKET Medical products agency in Sweden
Dnr.452:2008/83584.

Free sales certificate at the LÄKEMEDELSVERKET Medical products agency in Sweden.

TECHNICAL SPECIFICATIONS

Height:	40.9 "
Width:	29.1 "
Depth:	35.4 "
Overall Weight (Without Accessories):	48.5 lbs.
Working Load Limit:	441 lbs.
Power Supply:	N/A