



EZ Way, Inc.

Service Manual

Model S400 and S500 Smart Stand®



EZ Way, Inc.

Table of Contents

Parts Breakdown	3
Monthly Maintenance Checklist	7
Smart Stand® Operating Instructions	9
Scale Calibration10
Advanced Smart Stand® Features11
Wiring Schematic14
Trouble-Shooting Guide15



EZ Way, Inc.

S400PN – S500PN Non Scale Parts Diagram

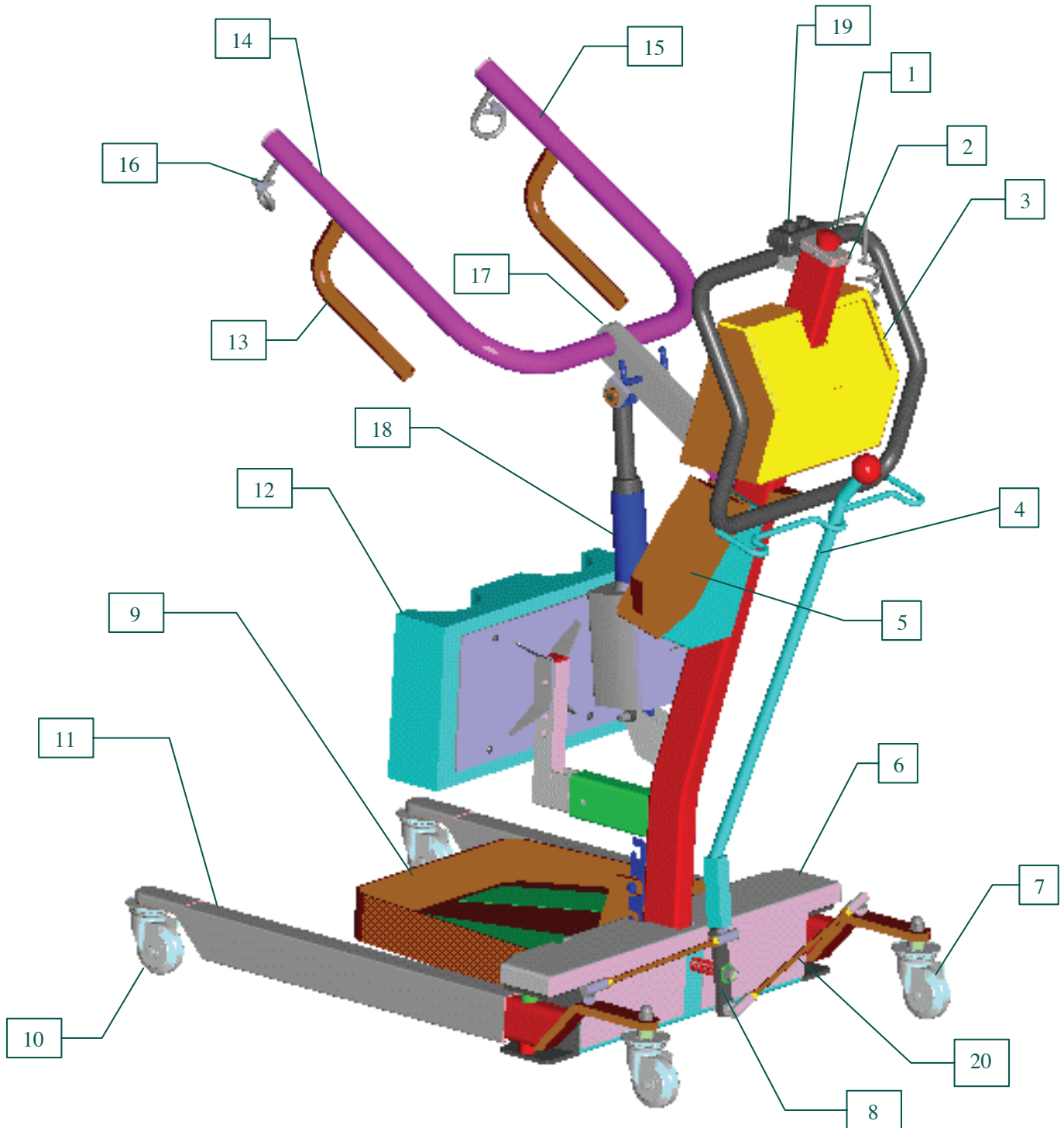



EZ Way, Inc.

S400PN – S500PN Non Scale Parts List

400# EZ Smart Stand® w/out Scale Model S400PN

<u>Item</u>	<u>Part No.</u>	<u>Description</u>
1	11842	Switch Emergency Stop Button Lift & Stand
2	12190	Cover Mast Emergency Stop Switch Stand
3	12050	Shroud Assembly Stand Premier without Scale
4	13316	Handle Spreader Assembly Lift & Stand
5	11871	Battery Pack Assembly UL
6	11782	Cover Base Assembly Stand 400 lb.
7	11786	Caster Rear Lift & Stand
8	13310	Bar Pivot Chrome Plated Lift & Stand
9	11783	Platform Foot Assembly Stand
10	11790	Caster Front Assembly Lift & Stand
11	14550	Cover Leg Stand 400 lb. 500 lb.
12	50907	Pad Shin Assembly Stand 400 lb. & 500 lb.
13	12019	Hand Grip Assembly
14	50905	Pad Arm Right Stand Premier
15	50904	Pad Arm Left Stand Premier
16	11014	Safety Hook Spring
17	50932	Pad Head Stand 400 lb.
18	12013	Actuator Assembly - Stand
19	12706	Hand Control Assembly
20	13506	Linkage Rod Assembly Lift & Stand

500# EZ Smart Stand® w/out Scale Model S500PN

<u>Item</u>	<u>Part No.</u>	<u>Description</u>
1	11842	Switch Emergency Stop Button Lift & Stand
2	12190	Cover Mast Emergency Stop Switch Stand
3	12050	Shroud Assembly Stand Premier without Scale
4	13316	Handle Spreader Assembly Lift & Stand
5	11871	Battery Pack Assembly UL
6	12818	Cover Base Assembly Stand 500 lb.
7	11786	Caster rear Lift & Stand
8	13310	Bar Pivot Chrome Plated Lift & Stand
9	11783	Platform Foot Assembly Stand
10	11790	Caster Front Assembly Lift & Stand
11	14550	Cover Leg Stand 400 lb. 500 lb.
12	50907	Pad Shin Assembly Stand 400 lb. & 500 lb.
13	12019	Hand Grip Assembly
14	50905	Pad Arm Right Stand Premier
15	50904	Pad Arm Left Stand Premier
16	11014	Safety Hook Spring
17	50932	Pad Head Stand 400 lb.
18	12013	Actuator Assembly - Stand
19	12706	Hand Control Assembly
20	12821	Linkage Rod Assembly 600 lb. Lift & 500 lb. Stand



EZ Way, Inc.

S400PS – S500PS With Scale Parts Diagram

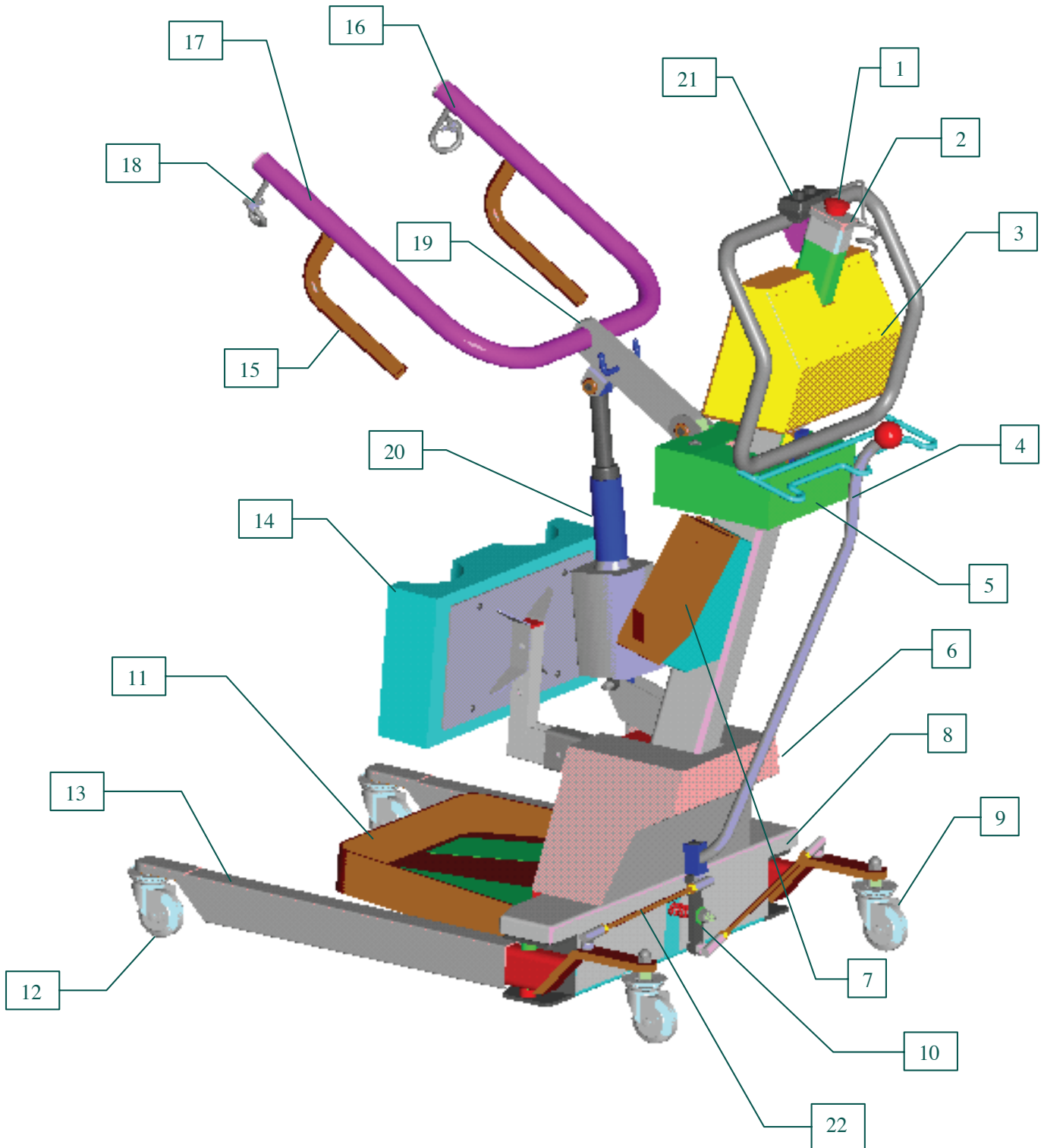



EZ Way, Inc.

S400PS – S500PS With Scale Parts List

400# EZ Smart Stand® with Scale Model S400PS

<u>Item</u>	<u>Part No.</u>	<u>Description</u>
1	11842	Switch Emergency Stop Button Lift & Stand
2	12190	Cover Mast Emergency Stop Switch Stand
3	12049	Shroud Assembly Stand Premier with Scale
4	12848	Handle Spreader Assembly Stand with Scale
5	12845	Cover Loadcell Stand w/Scale 400 lb. 500 lb.
6	12862	Cover Flexure Plates Assembly Stand w/Scale
7	11871	Battery Pack Assembly UL
8	11782	Cover Base Assembly Stand 400 lb.
9	11786	Caster, rear 3 in. grey
	11885	Caster, 4 in. red
10	13310	Bar Pivot Chrome Plated Lift & Stand
11	11783	Platform Foot Assembly Stand
12	11790	Caster Front Assembly Lift & Stand
	11885	Caster, 4 in. red
13	14550	Cover Leg Stand 400 lb. 500 lb.
14	50907	Pad Shin Assembly Stand 500 lb.
15	12019	Hand Grip Assembly
16	50905	Pad Arm Right Stand Premier
17	50904	Pad Arm Left Stand Premier
18	11014	Safety Hook Spring
19	50932	Pad Head Stand 400 lb.
20	12013	Actuator Assembly - Stand
21	12706	Hand Control Assembly
22	13506	Linkage Rod Assembly Lift & Stand

500# EZ Smart Stand® with Scale Model S500PS

<u>Item</u>	<u>Part No.</u>	<u>Description</u>
1	11842	Switch Emergency Stop Button Lift & Stand
2	12190	Cover Mast Emergency Stop Switch Stand
3	12049	Shroud Assembly Stand Premier with Scale
4	12848	Handle Spreader Assembly Stand with Scale
5	12845	Cover Loadcell Stand w/Scale 400 lb. 500 lb.
6	12862	Cover Flexure Plates Assembly Stand w/Scale
7	11871	Battery Pack Assembly UL
8	12818	Cover Base Assembly Stand 500 lb.
9	11786	Caster, rear 3 in. grey
	11885	Caster, 4 in. red
10	13310	Bar Pivot Chrome Plated Lift & Stand
11	11783	Platform Foot Assembly Stand
12	11790	Caster Front Assembly Lift & Stand
	11885	Caster, 4 in. red
13	14550	Cover Leg Stand 400 lb. 500 lb.
14	50907	Pad Shin Assembly Stand 500 lb.
15	12019	Hand Grip Assembly
16	50905	Pad Arm Right Stand Premier
17	50904	Pad Arm Left Stand Premier
18	11014	Safety Hook Spring
19	50932	Pad Head Stand 400 lb.
20	12013	Actuator Assembly - Stand
21	12706	Hand Control Assembly
22	12821	Linkage Rod Assembly 600 lb. Lift & 500 lb. Stand



EZ Way, Inc.

Smart Stand[®] Safety & Maintenance Checklist

The EZ Way stand requires a minimum of servicing to keep it in good working order. Nevertheless, it is important that certain basic checks be periodically made by maintenance staff to ensure on-going safety throughout the life of the device.

The manufacturer suggests that the following components and operating points be scheduled for inspection at intervals not greater than one month. Any detected deficiency must be rectified before the stand is put back into service.

1. Check all bolts to ensure they are tight. Remove covers as necessary for inspection.

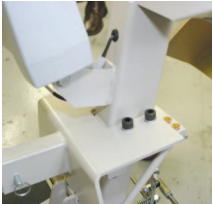

BASE



PIVOT



REAR WHEEL



FRONTWHEEL

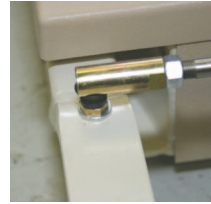

LINKAGE



SPREADER

2. Check arm to mast pivot bolt by removing plastic cap to assure nut is tight and cotter pin is in place. If plastic cap is missing order replacement.



ARM TO MAST

3. Foot platform assembly pins need to be checked to assure they have not pushed in and still engage into base.

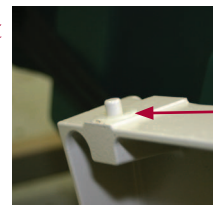

PIN ON FOOT PLATFORM

4. Check bolts on back of shin pad.



5. Safety tabs need to be checked to make sure they are installed correctly, not missing or torn.



6. Check mounting bolts of actuator top and bottom. Pay particular attention to top bolt hole for elongation.



ELONGATED



TOP OF ACTUATOR

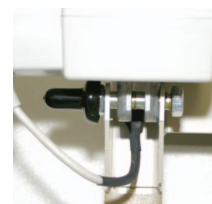

BOTTOM OF ACTUATOR



EZ Way, Inc.

Smart Stand[®] Safety & Maintenance Checklist



Check actuator for the following.

- a. Inspect the plastic housing for any dents or cracks.
- b. Inspect the cables to see if they have been cut or pinched.
- c. See if the actuator appears deflected when fully extended at full load.
- d. Verify that the mounting points do not have any cracks or other defects.
- e. Apply a heavy grease to actuator mounting pins as needed.
- f. Verify that the inner or outer tubes do not have any dents, dings, or large scratches in them.

Contact EZ Way's Service Department at 1-800-627-8940 if the actuator shows any signs of the issues listed above.

7. At six month intervals, attach a load equivalent to the rated capacity of the stand to the unit. Raise and lower the load with the stand. Listen for any unusual noises while operating the unit. With the test load applied to the stand, check all structural welds for any signs of stress or fatigue cracks. If any unusual noises or cracks are found, stop using the stand and call the EZ Way Service Department immediately!
8. Test the Emergency Stop Switch. If the switch does not stop the stand when activated, call the EZ Way Service Department immediately!
9. Perform a functional test of the emergency lowering feature of the stand actuator if it is so equipped.
10. Perform a functional test of the anti-pinch feature of the stand actuator. This feature turns the actuator off when lowering the stand arm if an obstruction is encountered.
11. Check all the wheels and brakes to make sure they are functioning properly. Hair that gets picked up and wrapped in between wheels should be cleaned out so that the stand will roll easily.
12. Do a visual check for any damaged, missing or loose parts. Repair as necessary.
13. Check the entire harness for damage or wear, including the loops and stitching. If damage or wear is present, discard the harness and order a new one. It is recommended that harnesses be replaced after one year or if the harness shows any sign of damage or wear.
14. When cleaning the stand, do not spray any liquid cleaners directly onto the front panel graphics. To clean, use a glass cleaner such as Windex, dampen a cloth and wipe the panel.

****IMPORTANT NOTICE****

It is the responsibility of the purchaser to ensure that regular maintenance inspection is conducted on this device by competent staff.



EZ Way, Inc.

Smart Stand® Operating Instructions

MOVING ARM

To move the arm, press and hold the key for the desired direction of travel.

WEIGHING

Capturing New Weight

To capture a new weight, press the Weight key. While capturing the new weight a “?” will be seen indicating that the control is waiting for a weight to lock in. Once the weight has locked in a “*” will be seen. At this point, the weight has been locked in and saved into memory as the next recall weight.

Recall Last Weight

To recall previous weight, press the ‘down’ key and then ‘weight’ key. The weight will be displayed with a # symbol indicating that the weight is recalled.

MENUS

Enter Customer Settings Menu/Weight Calibration

1. After power up sequence, press and hold the Down key followed quickly by the Up key and hold both keys for 5 seconds.
2. Back out of Customer Settings by hitting left toggle switch.

Navigating through Menus

1. Pressing the Up or Down keys will move (also described as ‘scrolling’ below) through menu items.
2. Pressing the Right Toggle Switch (also described as ‘enter’) will enter into a menu selection.
3. Pressing the Left Toggle Switch (also described as ‘exit’) key will exit the menu selection.

Changing Parameter Values

1. Pressing the Up or Down keys will change the parameter value.
2. Pressing the Right Toggle Switch will lock the value into memory.
3. Pressing the Left Toggle Switch will back out of the parameter without saving the value.



SCALE CALIBRATION PROCEDURE

1. **Nothing should be hanging from the arm assembly or on the foot platform.** During the time the stand is turned ON and the battery level is displayed, the microprocessor is resetting Zero.
2. Press the **“ON/OFF”** key to power up the unit.
3. **Pick up or put on footplate an exact and known weight** (preferably 200 lb.). (Note: Once in the calibration menu, the stand is no longer able to move.)
4. Press the **“WEIGHT”** key to ensure the scale is functional.
5. Enter the calibration menu. After power up sequence, press and hold the **“DOWN”** key followed quickly by the **“UP”** key and hold both keys for 5 seconds.
6. Press the **“UP”** key to calibration menu. Press **Enter** (right toggle) twice.
7. Scroll to the proper calibration weight and enter selection. (Note: If harness is not attached, subtract 3 lb.)
8. **“Begin weight calibration”** is displayed. Press **Enter** (right toggle), select **Yes**, and press **Enter** (right toggle) to execute calibration. Display shows **“CALIBRATING”**.
9. When the display leaves this menu selection, it will have been calibrated to the selected weight. Exit the calibration menu.
10. Press **“WEIGHT”** key to verify calibrated weight to 1% accuracy. Calibration is now complete.



EZ Way, Inc.

Advanced Smart Stand[®] Features

BATTERY MESSAGING

Charge Battery – For Battery Maintenance

When the battery level gets below 22.7 volts, the display reads 'CHARGE BATTERY'.

Swap Battery – For Battery Protection

When the battery level gets below 22.3 volts, the display reads 'SWAP BATTERY' and only allows the unit to go in the down direction.

REMINDER MESSAGING

Inspection Overdue – For Scheduled Maintenance

The purpose of the inspection overdue reminder is to notify the customer that the stand needs to be inspected every 30 days.

FAULT MESSAGING

Duty Cycle Fault – For Actuator Protection

The stand actuators are rated for a specific duty cycle. What this means is that for every 20 minutes of elapsed time, the stand is rated to run 5 minutes. If the stand is operated in excess of 5 minutes at a time, the actuator may be damaged. When the duty cycle fault occurs, the following message comes up: 'Actuator Duty Cycle Fault...Cooling'. When this fault occurs, the customer can lower the patient. After lowering, the customer will need to wait 15 minutes to cool the actuator motor.

Actuator Overload – For Arm Protection

1. When an Up or Down command is executed, the circuit board monitors current consumed by the actuator. If the actuator consumes too much current, the control will recognize this condition.
2. At this time an 'Actuator Overload' message will display. The 'Actuator Overload' may result from lifting a patient/object that is too heavy, arm pinched against obstruction, or mechanical failure (internal actuator binding, etc.).
3. To override an 'Actuator Overload', press the down key. The arm will only operate in the down direction during a current overload. Note: This feature is available on all scale and non-scale units.

Weight Overload – For Arm Protection

1. When an Up or Down command is executed, the control monitors weight readings from the load cell. If the weight is measured too high, the control will recognize this condition.
2. At this time a 'Weight Overload' message will display. The Weight Overload may result from accidental lifting of a trapped harness or accidental lifting of an overweight patient.
3. To override a 'Weight Overload', press the down key. The arm will only operate in the down direction during a Weight Overload. Note: This feature is only available on scale units.



ADVANCED DIAGNOSTICS

Real Time Current – For Actuator Diagnostics

1. When the display shows “EZ Stand Awake”, press the hidden key. Now whenever the stand is in motion, the real time current will be shown.
2. The Real Time Current function will disable after power cycling the unit.

Real Time Voltage – For Battery Diagnostics

1. In the case of a possible battery or connection issue the battery voltage can be monitored real-time. Go to the Customer Settings menu.
2. Press the Enter key several times until you see “Volts = ...”.

CUSTOMER SETTINGS MENU (FULL DESCRIPTIONS)

Within the Customer Settings Menu there are several functions that provide customer feedback. The functions include; an Inspection Reminder, stand usage, and diagnostic information. Below is a description of each function within the Customer Settings Menu.

Inspection Reminder – For Scheduled Maintenance

The Inspection Reminder function tracks the last inspection occurrence. When the duration of time since the last inspection exceeds 30 days a reminder message will appear when the unit is powered up. The purpose of the inspection reminder is to notify the customer that the lift or stand needs to be inspected with the ‘EZ Way Safety & Maintenance Checklist’ form (see attached). When the checklist is complete the reminder is to be reset in the Customer Settings Menu as described below.

1. To enable/disable the Inspection Reminder enter the Customer Settings Menu.
2. Press enter. Scroll to Inspection Reminder. Press enter. Scroll to choose Yes or No. Press Enter.
3. Press Exit twice.

Inspection Complete

1. If ‘INSPECTION OVERDUE’ appears during power up complete the ‘EZ Way Safety & Maintenance Checklist’.
2. Enter the Customer Settings Menu.
3. Press enter. Scroll to Inspection Complete. Press enter. Scroll to choose Yes. Press Enter.
4. Press Exit twice.

Overweight Counts – For Diagnostic Tracking with Scale

The Overweight Counts function tracks ‘Weight Overload’ occurrences. When a ‘WEIGHT OVERLOAD’ occurs the ‘Overweight Counts’ register increments one. This read-only information provides customer feedback for; accidental lifting of a trapped harness, or accidental lifting of overweight patient. This information is available for units with the scale option only.



EZ Way, Inc.

Advanced Smart Stand® Features

Actuator Minutes – For Tracking Stand Usage

The Actuator Minutes function tracks the accumulated amount of raising and lowering time of the actuator. With each minute of runtime the 'Actuator Minutes' register increments one. A typical lift takes one minute of runtime. This read-only information provides accurate customer feedback of stand usage within the care facility. In the event of an actuator replacement the 'Actuator Minutes' register can be reset by calling an EZ Way Service representative.

Actuator Overload Counts – For Diagnostic Tracking with Actuator

The Actuator Overload Counts function tracks Actuator Overload occurrences. When an 'ACTUATOR OVERLOAD' occurs the 'Actuator Overload Counts' register increments one. This read-only information provides customer feedback for; accidental lifting of a trapped harness, accidental lifting of arm against obstruction, or accidental lifting of overweight patient.

Lift/Stand Total Minutes – For Tracking Stand Usage

'Lift/Stand Total Minutes' function tracks the accumulated amount of raising and lowering time of the actuator on the unit. The 'Lift/Stand Total Minutes' is not reset when an actuator is replaced. This read-only information provides accurate customer feedback of lift usage for the entire life of the stand.

Volts= - For Battery Diagnostics

The 'Battery Voltage' function tracks the real-time voltage of the battery. This information is useful in diagnosing issues related to battery level.

SW Rev. – For Software Diagnostics

The 'Software Revision' is used for tracking software changes. For example if the original code begins with version 1.3 and changes are made to the original code the next revision of code will display version 1.4. New controls with version 1.8 will have software updates included.



EZ Way, Inc.

Smart Stand[®] Wiring Schematic

Emergency Stop Switch

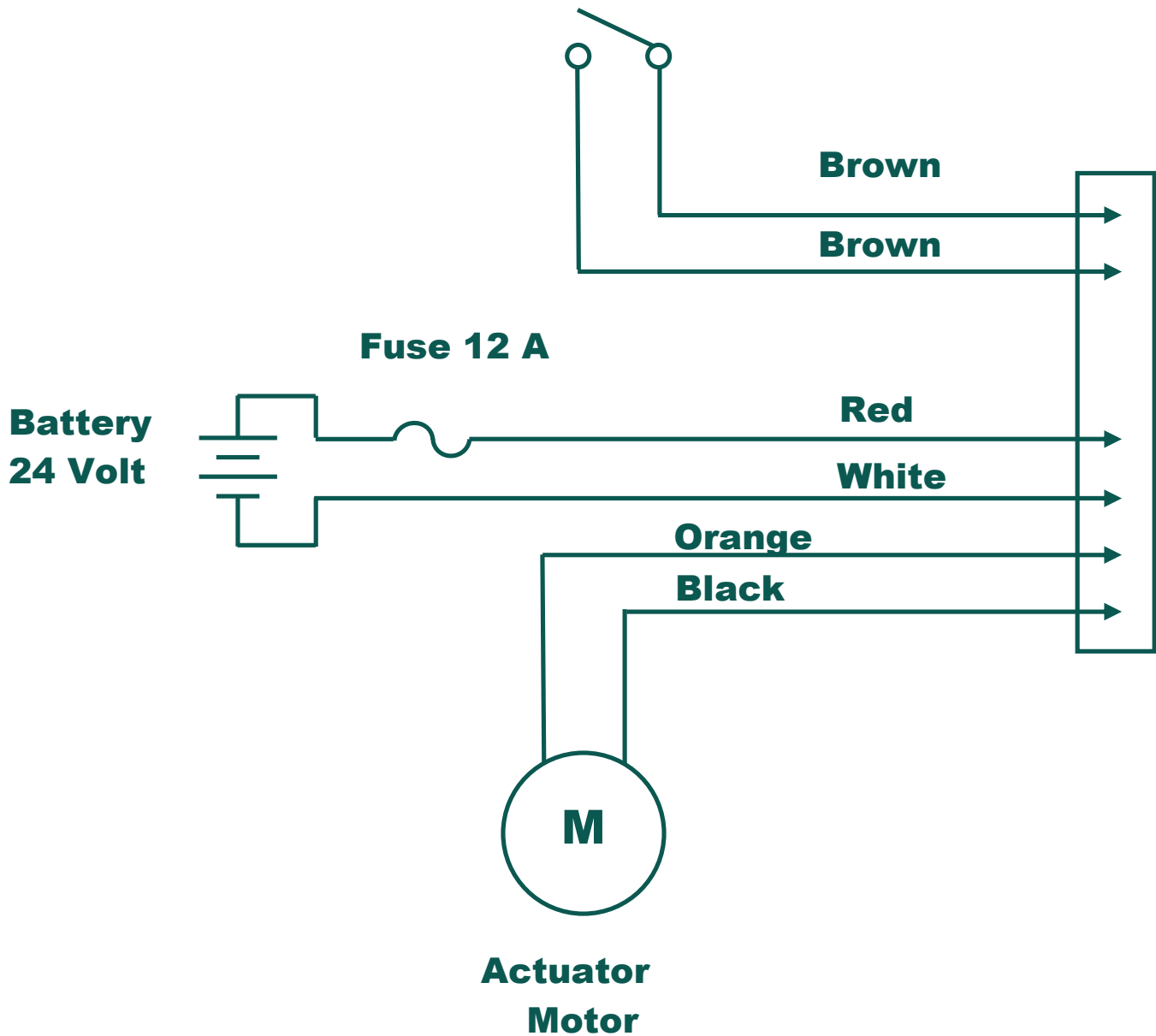



Problem	Solution
Machine will not turn on	<p>Check battery. Make sure it is fully charged.</p> <p>Check battery receiver plug. Make sure prongs are not bent or pushed in. Call EZ Way Service for replacement.</p> <p>Check fuses.</p> <p>Check green connector on PC board for good connection. Make sure all wires are tight.</p> <p>Make sure on/off button is not flattened out.</p> <p>Check if green LED is flashing on board. Flashing LED indicates the PCB is getting power.</p> <p>Make sure W6 jumper is in place.</p>
No up/down but display works	<p>Check connection at actuator.</p> <p>Check voltage at actuator connection. If 24 VDC are present then the actuator may need replaced.</p> <p>If voltage is not good, check black and orange wires on green connector at circuit board. Make sure they are not loose.</p> <p>Call Service if voltage is not good and connection is good.</p>
Continuous up/down	<p>Unhook toggles and airlines from board. If problem still persists call EZ Way Service.</p>